

C60-EXT-75

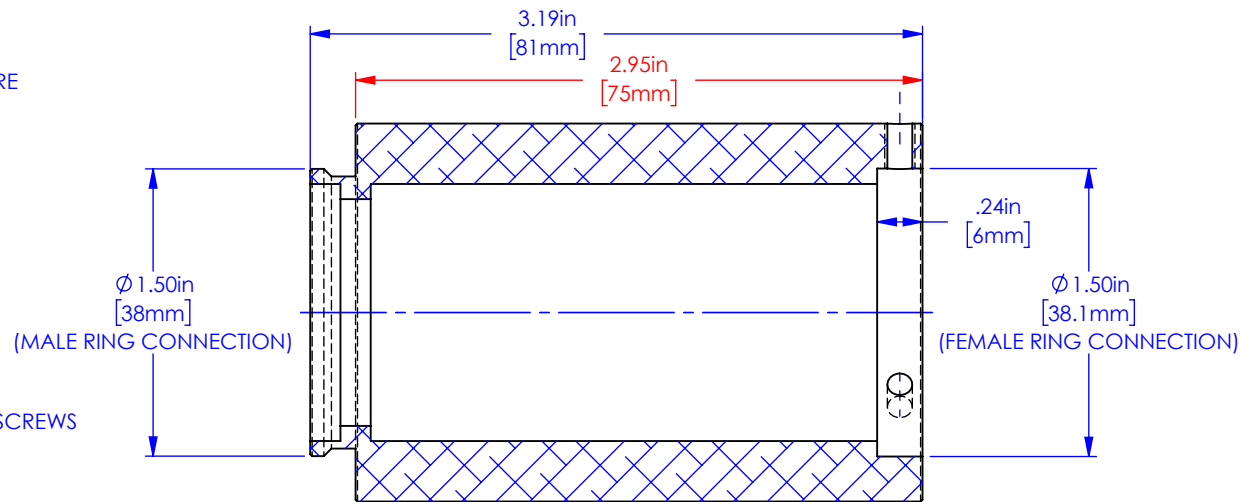

SECTION A-A

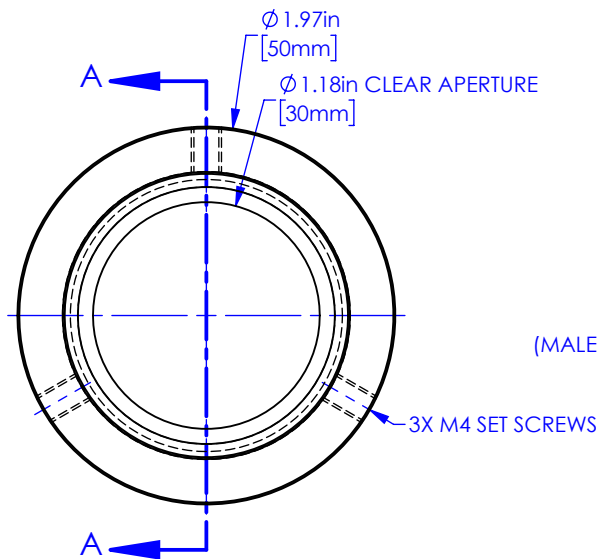

PROPRIETARY AND CONFIDENTIAL
 THE INFORMATION CONTAINED IN THIS DRAWING IS THE SOLE PROPERTY OF APPLIED SCIENTIFIC INSTRUMENTATION. ANY REPRODUCTION IN PART OR AS A WHOLE WITHOUT THE WRITTEN PERMISSION OF APPLIED SCIENTIFIC INSTRUMENTATION IS PROHIBITED.

APPLIED SCIENTIFIC INSTRUMENTATION
 29391 W ENID RD
 EUGENE, OR 97402-9533
 PHONE: (541)461-8181
 FAX: (541)461-4018

UNLESS OTHERWISE SPECIFIED
 DIMENSIONS ARE IN INCHES
 .xx ± .01
 .xxx ± .005
 .xxxx ± .0002
 FRACTIONS ± 1/32
 ANGLES ± 1°

DESCRIPTION
 75mm EXTENSION TUBE
 w/ MALE TO FEMALE C60-RING MOUNTS

DRAWN BY/DATE
 M.ANTHONY 11-16-20

CHECKED BY/DATE
 V.MARSO
 J.DANIELS 11-16-20

SCALE
 1:1

REV
 -

MATERIAL
 6061, ANODIZED BLK

DRAWING #
 C60-EXT-75